

Craftsman
doors born of passion

STYLISH
DISTINGUISHED
HANDMADE



Contents

Welcome		p 3
A better class of door		p 5
Built to last - construction detail		p 6
Hardware & glazing		p 8
Colour range		p 10
The Contemporary range...		p 12-33
The Foxley	MFF5	p 14
The Albury	MFJ3	p 16
The Whittingham	MF37	p 18
The Glengarry	MFF6	p 19
The Rufford	MF36	p 20
The Mercia	MFC3	p 22
The Rockingham	MFH9	p 24
The Hampton	MF47	p 25
The Dalby	MFH6	p 26
The Wentwood	MFF1	p 28
The Portland	MF60	p 29
The Charlcote	MF61	p 30
The Heartwood	MFM7	p 31
The Whinfell	MF6F	p 32
The Winterfold	MF6G	p 33
The Traditional range...		p 34-56
The Sherwood	MFD5	p 36
The Parkhurst	MF23	p 37
The Arden	MF11	p 38
The Marston	MF03	p 40
The Shackleford	MF85	p 42
The Highgate	MFM2	p 43
The Ashdown	MF15	p 44
The Charnwood	MFA3	p 46
The Newstead	MF04	p 48
The Epping	MF14	p 50
The Dean	MF07	p 52
The Galloway	MF08	p 53
The Hatfield	MFM3	p 54
The Silverhill	MFM5	p 55
The Kensington	MFM5(K)	p 56
Specifications...		p 57-71
Side panel options		p 57-58
Toplights & sidelights		p 59-60
Colours		p 61
Hardware options		p 62-69
Glazing options		p 70-71
Frame, sill & threshold options		p 72
Guarantee		p 74
Document L Compliance		p 75
Accreditations		p 76
Customer support		p 77



Calibre Craftsman

The precision engineered timber door - a true innovation for your home

The Calibre Craftsman is a door that speaks of precision engineering, quality construction and stunning good looks. With 30 door styles to choose from and with 24 beautiful lifestyle colours available, Calibre Craftsman is a truly outstanding door.

Your home deserves the very best and Calibre can provide that very thing. From our state-of-the-art premises in Nether Heage, Derbyshire, Calibre have been building beautiful doorsets since the 1990's. Named after the beautiful woodlands of Britain, the Craftsman is our premium timber door and is exceptional in every way.





The Galloway in Devonshire paint finish with Contemporary Brushed Steel hardware

Simply a better class of door

A class leader in strength, security and authentic craftsmanship

We are proud to state that the Calibre Craftsman door is second to none and the care and skill put into our doors shines through whilst the innovation and engineering will bear out over its lifetime. Named after the beautiful woodlands of Britain, the Craftsman door is a tangible investment in your home.

- **Precision engineered to last**
A combination of a Kerto Q core, Sapele mahogany lipping and Tricoya facings provide a stable, hard-wearing, water resistant door
- **Two door slab choices - 44mm and 54mm**
Whatever your requirement or application, we offer both 44mm and 54mm door thicknesses with double and triple rebates
- **Thermal core option**
For the best in energy efficiency opt for a thermal door with a Polyurethane insulating foam core
- **A complete hardware choice**
Four individual ranges to choose from that include: handles, knockers, letterboxes and centre door pulls
- **Beautiful glazing options**
Over 30 elegant glazing styles are available for many of the Craftsman door styles
- **Low-E glass panels**
Wherever possible we supply an energy efficient glass specification as standard - see page 70-71
- **Double and French Doors**
Calibre Craftsman doors are available as stunning double doors or glazed French doors - call us for a bespoke quotation
- **Safe and secure**
The unique construction of a Craftsman door provides an incredibly strong defence for your home
- **24 stunning colours**
From fiery reds to cool blues and all the shades in between, our colour range is first class
- **Frame, sill and threshold options**
A wide range of options to complete your door specification including Part M low threshold
- **Document L Compliance**
Meets UK Building Regulations for replacement door applications

Why an engineered timber door and not a standard timber door?



As beautiful as a traditional timber door can be, wood in its purest form, is not the best material for this application. We have “designed out” all of the inherent problems usually experienced, and the Craftsman is an all round better, more reliable door for your home.

- No yearly maintenance
- No warping and twisting
- No draughts caused by shrinkage
- No rotting and deterioration
- No weather penetration
- No unstable timbers
- No flaking and crazing of paint finish
- No sticking and catching

A door engineered to perform

The most innovative, highly engineered door - direct from Calibre

It has taken more than two decades of research and development for the Craftsman door to evolve into the innovative, structurally sound product that we know today. Using years of experience in joinery and traditional craftsmanship, whilst harnessing the latest in innovative technologies and materials, the Craftsman door has ascended as the industry leader.

Our development team and workforce strive to produce the very best doorsets in the market place.

Their craftsmanship and attention to detail are obvious in the complex construction and advanced materials used in each and every Craftsman door, guaranteeing a sound door for many years to come.

Strong and Secure: The sturdy door blade with solid core and timber/aluminium capped frame is an ideal choice for quality, strength and the best in innovative engineering.

Craftsman doors are available as:

- 44mm blade (solid or thermal)
- 54mm blade (solid or thermal)

Calibre are proud to manufacture with...



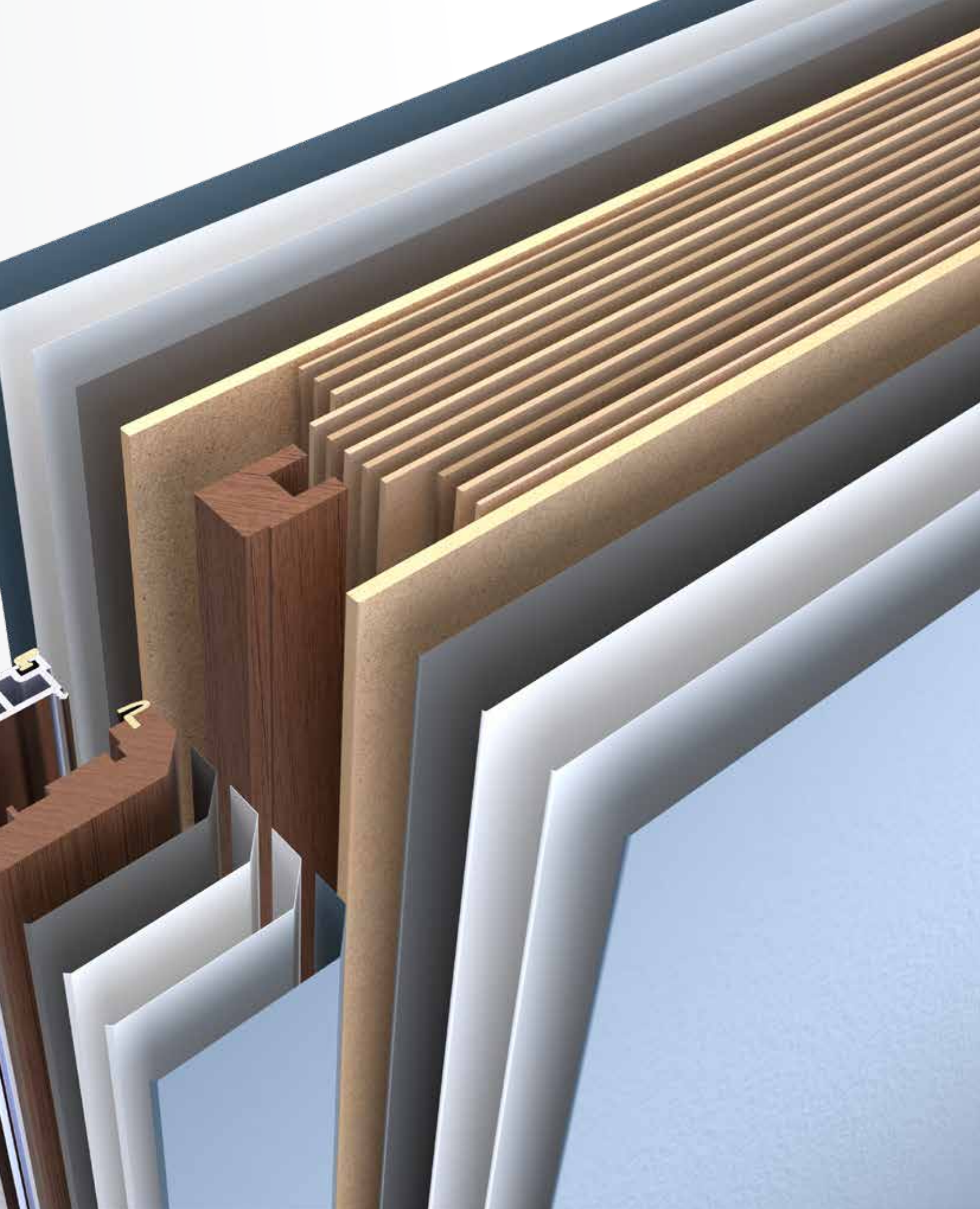

Dressed to impress...

The perfect door furniture to dress your Calibre Craftsman door

We've selected beautiful door hardware that complements the Craftsman door range perfectly. Whether your chosen style is a classic panelled door or a more contemporary door with a grooved design, we have the ideal hardware in range.

All Calibre Craftsman doors come with a standard handle, letterbox and knocker in a choice of four colours, four sturdy stainless steel or brass hinges and a secure multi-point lock as standard. See page 62-69 for details.



Standard Suited Hardware

Handle (lever and pad), letterboxes, knocker and spy hole available in four finishes: Polished Gold, Chrome, Satin and Black.



Painted Heritage Hardware

A stunning painted finish that gives a hammered artisan effect and is available in both black and pewter. Ideal for the cottage style doors.



Contemporary Hardware

Sleek, elegant furniture suitable for our contemporary door designs in brushed stainless steel. Choice of three handle styles, a pull and two knockers.



Premium Heritage Hardware

Beautifully hand forged in either a Black, Pewter, Brass or Chrome finish. Choose from three handle designs, a pull, three knockers and a letterbox.



Sweet Hardware

"Edgeless" hardware that looks modern and stylish. Handle, letterbox, knocker and escutcheon available in Gold, Chrome and Black finishes.

Let the daylight flood in...

Up to 30 glass designs to personalise your home with style

A glazed panel in your Craftsman door not only has the practical benefits of allowing light in, it also lets you reflect your own personal taste, style and creativity, effortlessly. Choose from up to 30 amazing glass designs to create that perfect first impression.

We have selected the most elegant and attractive designs which complement our stunning range of door styles. Whether you have chosen a traditional or contemporary style, we have the

ideal glazing choices to bring your door to life. Looking for something quirky? Choose a contemporary design for a traditional door or vice versa.

All our glazing products are manufactured to conform to the same exacting high standards as your Calibre Craftsman door, guaranteeing you peace of mind for years to come. Please note that wherever possible we supply energy efficient glass units as standard - see page 70.

Elegant glazing: Finesse is just one of up to 30 different decorative glass designs available with your Craftsman door. With its linear motifs, organic backing glass and crystal style centre, it is little wonder that it is one of our most popular designs.

More than just a splash of Colour



p43 wax seal BS04D45



p38 summer coral *



p37 lemon curd *



p22 pitted olive *



p55 bottle BS14C39



p25 chartwell BS14C35



p40 peacock RAL 5020



p28 cambridge blue *

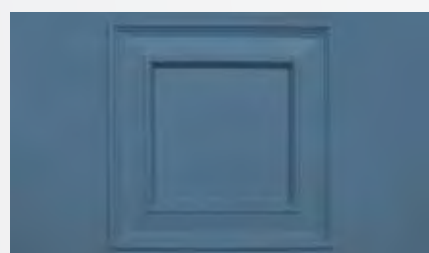

p32 devonshire *



p46 savile row BS20C40



p54 mulberry *



p42 merlot *



p36 bournville RAL 8016



p26 mannequin *



p16 potter's wheel *

Colours are representative only



p24 french sage *



p30 vellum BS10B15



p31 chalk cliff RAL 9016



p19 dove RAL 7035



p20 pebble grey RAL 7032



p50 agate grey RAL 7038



p18 smokestack RAL 7037



p14 anthracite RAL 7016



p52 whitby jet RAL 9005

Door colour featured on page...

* Paint mixed in-house

With primer, basecoat and topcoats - that's equivalent to 10 coats of paint

Bring your door to life with one of Calibre's lifestyle colours. Inspired by nature and our rich heritage, each shade delivers a unique character to your home. Be inspired by our latest colour palette and let your creativity run free.

Our paint, however is not just all about looks. Every door leaves our workshop with two water based layers of colour, two of undercoat and a primer, each applied using the latest spray technology.

All four layers add up to the equivalent of an impressive 10 coats of paint. With such a hard-wearing finish, you will be enjoying it for many years to come.

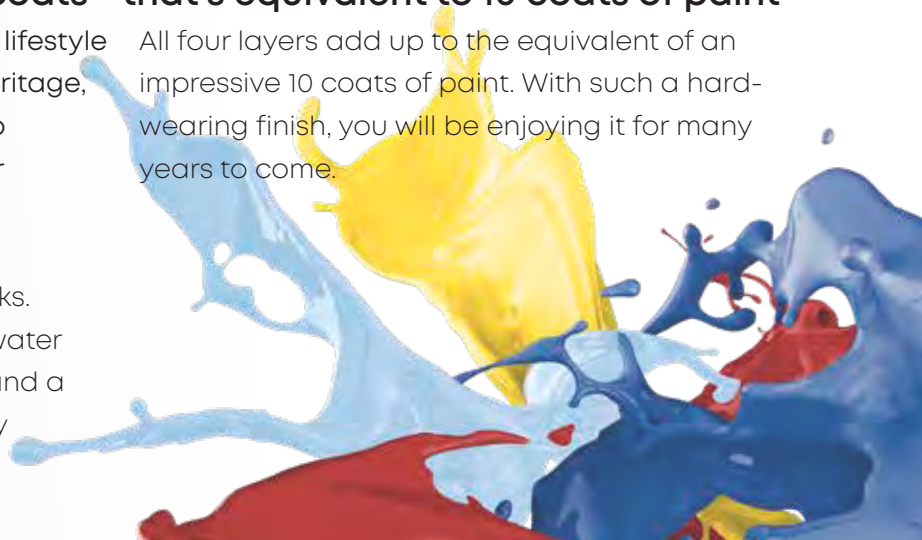



Modern styling

A contemporary classic: The Foxley in Anthracite paint with Contemporary Brushed Steel hardware and Satin glazing

Contemporary styles

The modern clean look of the Calibre Craftsman grooved designs is key to the Contemporary range. Using routed grooves to give the impression of tongue and groove boards, gives a designer look without any of the known downsides. There are no issues with twisting planks due to extremes of weather or moisture and no peeling or crazing of paint when boards swell or contract.

Our growing selection of modern designs have become very popular in recent years. The Foxley,

for example, with its characteristic long narrow glazed panel is the epitome of modernity when teamed with our stylish brushed stainless steel hardware suite.

The versatile looks of The Rufford, The Albury and The Whittingham when dressed in Black Premium Heritage Hardware, afford a cosy, country charm or alternatively with Polished Chrome hardware look perfectly at home in the city.

The Foxley



The Albury



The Whittingham



The Glengarry



The Rufford



The Mercia



The Rockingham



The Hampton



The Dalby



The Wentwood



The Portland



The Charlcote



The Heartwood



The Whinfell



The Winterfold



The Foxley

MFF5

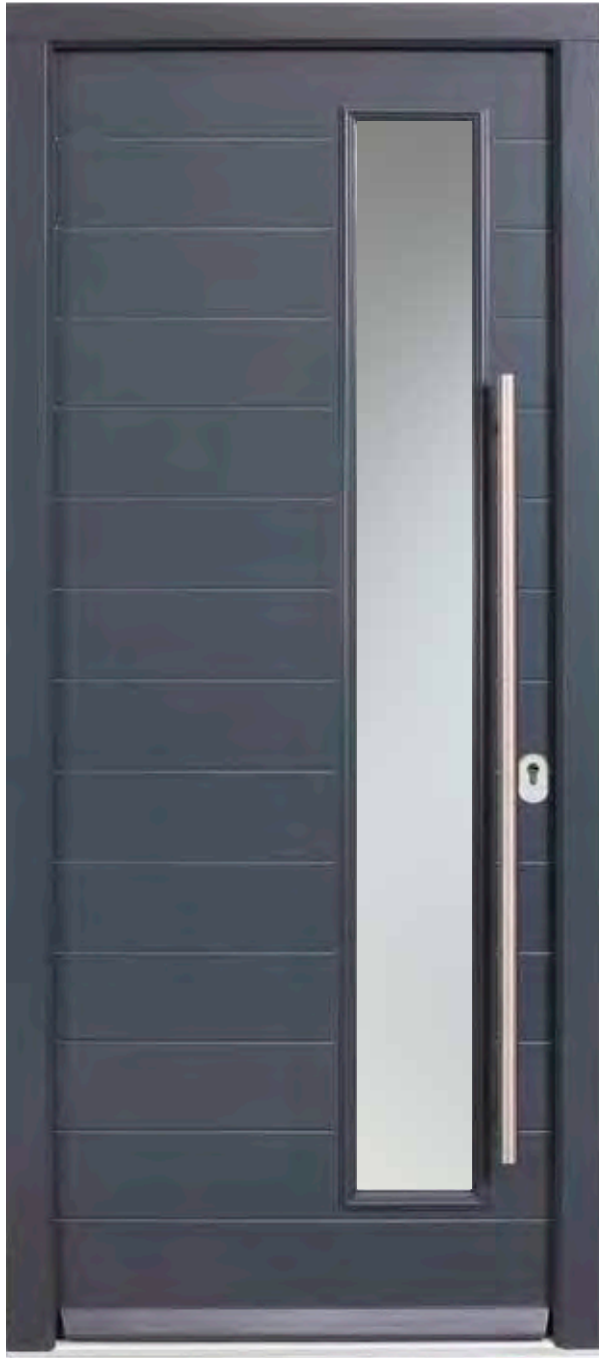

The Foxley is a popular addition to the contemporary range of Craftsman doors.

With its long single panel, The Foxley is as elegant as it is practical. Teamed with Brushed Stainless Steel hardware, this door is a modern classic.

The long narrow glazing aperture of the Foxley may be positioned on the left, the right or can be centred.



Photo: The Foxley in Anthracite with Satin glazing and Contemporary Brushed Stainless Steel hardware (off-set bar handle) with a timber capped aluminium frame

PVC-U Frame:

Min width : 854mm Max width : 1202mm
Min height : 2051mm Max height : 2195mm

Timber Clad Aluminium Frame:

Min width : 842mm Max width : 1190mm
Min height : 2045mm Max height : 2189mm

All sizes exclude Timber or PVC-U sills and extensions
If a low threshold is required please deduct 7mm from height

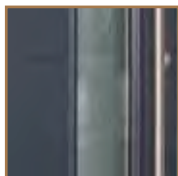



Diamond Bevel *



Diamond Red *
Also available in
Diamond Blue, Grey
or Green



Elegance



Murano Black *
Also available in
Murano Blue, Red,
Green or Purple



Prairie *



Reflections



Satin *



Obscure *
See page 71 for all
choices

* Laminate glass option available
Our decorative glazing designs are supplied with a choice of backing glass from Global Glass see page 71

The Albury

MFJ3



A simple yet assured design, the Albury combines integrity of design with a look that complements any home and is also suitable for a back door application.

Photo: The Albury in Potter's Wheel with Murano Blue glazing and Black ProLinea hardware with a timber capped aluminium frame

PVC-U Frame:

Min width : 724mm	Max width : 1202mm
Min height : 1865mm	Max height : 2195mm

Timber Clad Aluminium Frame:

Min width : 712mm	Max width : 1190mm
Min height : 1859mm	Max height : 2189mm

All sizes exclude Timber or PVC-U sills and extensions
If a low threshold is required please deduct 7mm from height

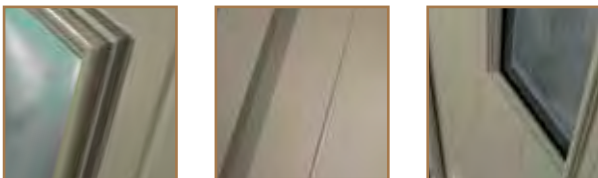



Diamond Bevel *



Diamond Red *
Also available in
Diamond Blue,
Grey or Green



Fleur *



Murano Red *
Also available in
Murano Blue, Black,
Green or Purple



Dorchester Blue
Also available in
Dorchester Amber
or Green



Flair



Finesse



Prairie



Simplicity
Available in Zinc
or Brass



Elegance



Crystal Diamond *



Diamond Cut



Reflections



Satin *



Obscure *
See page 71 for all
choices

* Laminated glass option available
Our decorative glazing designs are supplied with a choice of backing glass from Global Glass see page 71

The Whittingham

MF37



The feature double groove design of the Whittingham is unique in the Craftsman range and gives this door a sharp twist. Add your choice of glazing to complete the desired look.

Photo: The Whittingham in Smokestack with Obscure glazing and Polished Chrome ProLinea hardware with a timber capped aluminium frame

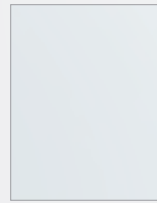

Satin *

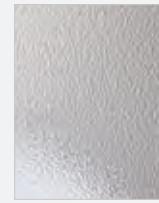

Obscure *

See page 71 for all choices

PVC-U Frame:

Min width : 724mm

Max width : 1202mm

Min height : 1865mm

Max height : 2195mm

Timber Clad Aluminium Frame:

Min width : 712mm

Max width : 1190mm

Min height : 1859mm

Max height : 2189mm

All sizes exclude Timber or PVC-U sills and extensions
If a low threshold is required please deduct 7mm from height



The Glengarry

MFF6



The Glengarry has a bold and uncompromising design with its horizontal lines and trio of small windows. Its unapologetic modern appearance is a beautiful statement for any home. The three glazing apertures of the Glengarry may be positioned on the left, the right or centred.



Photo: The Glengarry in Dove with Clear glazing and Contemporary Brushed Stainless Steel hardware with a timber capped aluminium frame

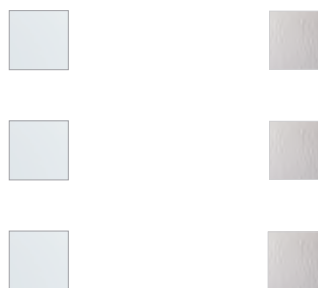

Satin *

Obscure *

See page 71 for all choices

PVC-U Frame:

Min width : 724mm

Max width : 1202mm

Min height : 1865mm

Max height : 2195mm

Timber Clad Aluminium Frame:

Min width : 712mm

Max width : 1190mm

Min height : 1859mm

Max height : 2189mm

All sizes exclude Timber or PVC-U sills and extensions
If a low threshold is required please deduct 7mm from height



* Laminated glass option available

Our decorative glazing designs are supplied with a choice of backing glass from Global Glass see page 71

The Rufford

MF36



With its arched tongue and groove style boards, the Rufford, when paired with our Premium Heritage hardware is the picture of country charm. Alternatively, add Contemporary hardware and you can enjoy a thoroughly modern look.

Photo: The Rufford in Pebble Grey with Prairie glazing and Sweet Chrome hardware with a timber capped aluminium frame

PVC-U Frame:

Min width : 724mm Max width : 1202mm
Min height : 1865mm Max height : 2195mm

Timber Clad Aluminium Frame:

Min width : 712mm Max width : 1190mm
Min height : 1859mm Max height : 2189mm

All sizes exclude Timber or PVC-U sills and extensions
If a low threshold is required please deduct 7mm from height

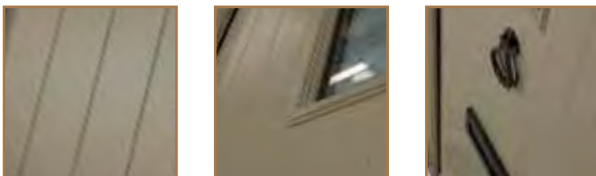



Diamond Bevel *

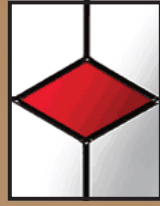

Diamond Red *
Also available in
Diamond Blue, Grey
or Green



Dorchester Blue
Also available in
Dorchester
Amber or Green



Reflections *

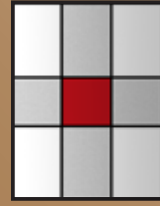

Lattice Red *
Also available in
Lattice Blue, Green
or Bevel



Finesse



Flair



Diamond Cut *



Elegance



Prairie *

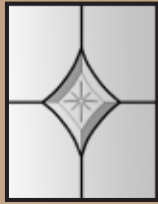

Crystal Diamond *



Simplicity *
Available in
Zinc or Brass

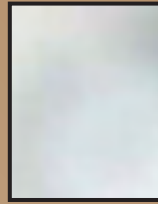

Satin *

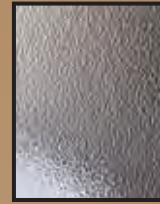

Obscure *
See page 71 for all
choices

* Laminated glass option available
Our decorative glazing designs are supplied with a choice of backing glass from Global Glass see page 71

The Mercia

MFC3



The Mercia is a classic design with its tongue and groove style boards and its diamond window. With a rich choice of glazing and a broad range of hardware, the Mercia is perfectly suited to many locations.

Photo: The Mercia in Pitted Olive with Murano Red glazing and Pewter Premium Heritage hardware with a timber capped aluminium frame

PVC-U Frame:

Min width : 724mm	Max width : 1202mm
Min height : 1865mm	Max height : 2195mm

Timber Clad Aluminium Frame:

Min width : 712mm	Max width : 1190mm
Min height : 1859mm	Max height : 2189mm

All sizes exclude Timber or PVC-U sills and extensions
If a low threshold is required please deduct 7mm from height

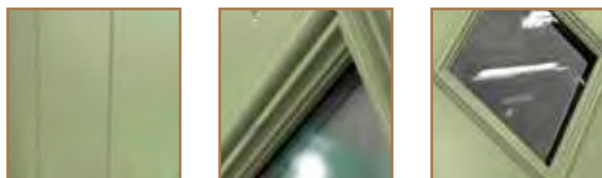



Diamond Bevel *



Diamond Red *
Also available in
Diamond Blue, Grey
or Green

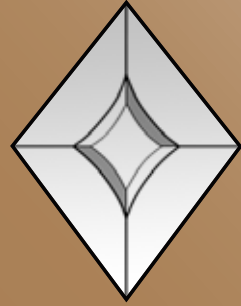

Crystal Diamond *



Lattice Red *
Also available in
Lattice Blue, Green
or Bevel



Murano Red *
Also available in
Murano Blue, Black,
Green or Purple

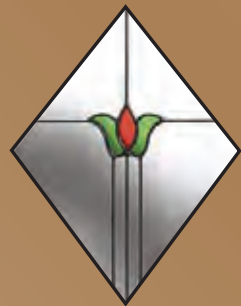

Fleur *



Satin *

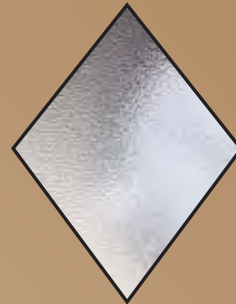

Obscure *
See page 71 for all
choices

* Laminated glass option available
Our decorative glazing designs are supplied with a choice of backing glass from Global Glass see page 71

The Rockingham

MFH9



With its porthole style window and tongue and groove scratch, the Rockingham gives an air of the nautical, however, its clean crisp lines make it a popular choice across many modern homes.

Photo: The Rockingham in French Sage with Obscure glazing and Contemporary Brushed Stainless Steel hardware with a timber capped aluminium frame

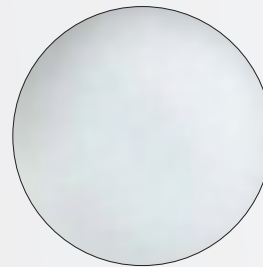

Satin *

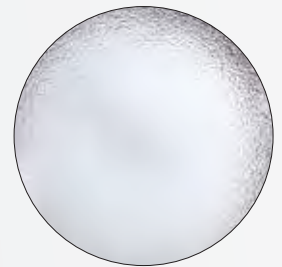

Obscure *
See page 71 for all choices

PVC-U Frame:

Min width : 724mm	Max width : 1202mm
Min height : 1865mm	Max height : 2195mm

Timber Clad Aluminium Frame:

Min width : 712mm	Max width : 1190mm
Min height : 1859mm	Max height : 2189mm

All sizes exclude Timber or PVC-U sills and extensions
If a low threshold is required please deduct 7mm from height



* Laminated glass option available
Our decorative glazing designs are supplied with a choice of backing glass from Global Glass see page 71

The Hampton

MF47



Often utilised when privacy is paramount or for back door applications, the Hampton is a design classic with its grooved board style. The simple nature of its design makes it a best-selling door.

Photo: The Hampton in Chartwell with Anvil Chrome hardware and a timber capped aluminium frame

PVC-U Frame:

Min width : 724mm	Max width : 1202mm
Min height : 1865mm	Max height : 2195mm

Timber Clad Aluminium Frame:

Min width : 712mm	Max width : 1190mm
Min height : 1859mm	Max height : 2189mm

All sizes exclude Timber or PVC-U sills and extensions
If a low threshold is required please deduct 7mm from height



The Dalby

MFH6



The quirky design of The Dalby makes this door a best-seller in the Craftsman range. With three large diamond apertures which can be glazed with a choice of decorative glass design, the Dalby enjoys stunning good looks.

Photo: The Dalby in Mannequin with Simplicity Zinc glazing and Anvil Chrome hardware with a timber capped aluminium frame

PVC-U Frame:

Min width : 724mm	Max width : 1202mm
Min height : 1865mm	Max height : 2195mm

Timber Clad Aluminium Frame:

Min width : 712mm	Max width : 1190mm
Min height : 1859mm	Max height : 2189mm

All sizes exclude Timber or PVC-U sills and extensions
If a low threshold is required please deduct 7mm from height

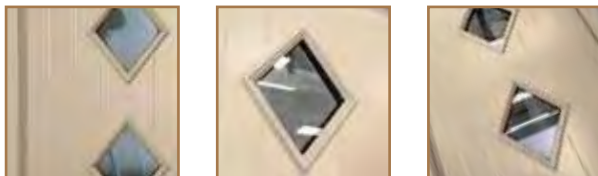



Diamond Bevel *



Diamond Red *
Also available in
Diamond Blue, Grey
or Green

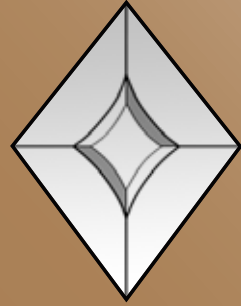

Crystal Diamond *



Lattice Red *
Also available in Lattice
Blue, Green or Bevel



Murano Red *
Also available in
Murano Blue, Black,
Green or Purple

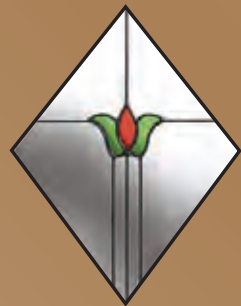

Fleur *



Satin *



Obscure *
See page 71 for all
choices

* Laminated glass option available
Our decorative glazing designs are supplied with a choice of backing glass from Global Glass see page 71

The Wentwood

MFF1



An unglazed slab with full width horizontal grooves defines the Wentwood and gives it a more contemporary feel than panelled door styles. With no glass set to navigate this door style is a good canvas for hardware and door furniture.

Photo: The Wentwood in Cambridge Blue with ProLinea hardware and a timber capped aluminium frame

PVC-U Frame:

Min width : 724mm	Max width : 1202mm
Min height : 1865mm	Max height : 2195mm

Timber Clad Aluminium Frame:

Min width : 712mm	Max width : 1190mm
Min height : 1859mm	Max height : 2189mm

All sizes exclude Timber or PVC-U sills and extensions
If a low threshold is required please deduct 7mm from height



The Portland

MF60



The charming cottage window on the Portland stable door makes it a perfect compromise between the unglazed Heartwood and the half-glazed Charlcote. A beautiful stable door!

Photo: The Portland in French Sage with Satin glazing and Premium Heritage hardware in Pewter and a timber capped aluminium frame

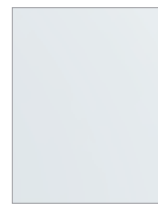

Satin *



Obscure *

See page 71 for all choices

Timber/PVC-U Clad Aluminium Frame:

Min width : 712mm

Max width : 1190mm

Min height : 1859mm

Max height : 2189mm

All sizes exclude Timber sills and extensions

If a low threshold is required please deduct 7mm from height

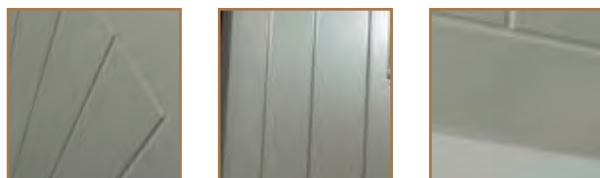

* Laminate glass option available

Our decorative glazing designs are supplied with a choice of backing glass from Global Glass see page 71

The Charlcote

MF61



The Charlcote is our most popular stable door and often used at the rear of a property. Opening the top half of the door allows ventilation whilst preventing children and pets from straying outdoors.

Photo: The Charlcote in Vellum with Satin glazing and ProLinea Black hardware and a timber capped aluminium frame

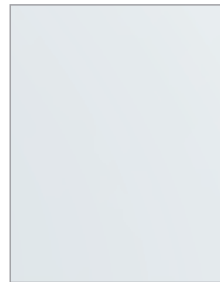

Satin *



Obscure *

See page 71 for all choices

Timber/PVC-U Clad Aluminium Frame:

Min width : 712mm Max width : 1190mm
Min height : 1859mm Max height : 2189mm

All sizes exclude Timber sills and extensions
If a low threshold is required please deduct 7mm from height



* Laminate glass option available

Our decorative glazing designs are supplied with a choice of backing glass from Global Glass see page 71

The Heartwood

MFM7



The Heartwood stable door style best demonstrates the vertical tongue and groove effect and the painted finish of the Craftsman range. This stable door provides total privacy until it is fully or half opened.

Photo: The Heartwood in Chalk Cliff with Premium Heritage Hardware in Black and a timber capped aluminium frame

Timber/PVC-U Clad Aluminium Frame:

Min width : 712mm Max width : 1190mm
Min height : 1859mm Max height : 2189mm

All sizes exclude Timber sills and extensions
If a low threshold is required please deduct 7mm from height



The Whinfell

MF6F



Based on the popular Portland, the Whinfell is an impressive looking selection. With a handsome geometric tongue and groove design, this door is both stylish and functional.

Photo: The Whinfell in Devonshire with Satin glazing and Chrome Premium Heritage Hardware with a timber capped aluminium frame

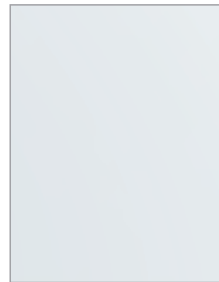

Satin *



Obscure *

See page 71 for all choices

Timber/PVC-U Clad Aluminium Frame:

Min width : 712mm Max width : 1190mm
Min height : 1859mm Max height : 2189mm

All sizes exclude Timber sills and extensions
If a low threshold is required please deduct 7mm from height

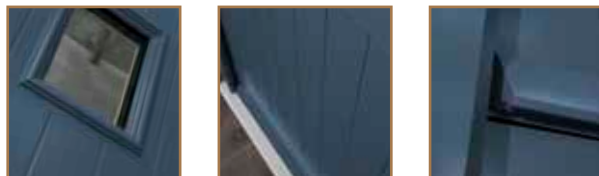

* Laminate glass option available

Our decorative glazing designs are supplied with a choice of backing glass from Global Glass see page 71

The Winterfold

MF6G



The Winterfold stable door is a great choice for any home. Featuring a sweeping curved groove in the design, it is perfectly paired with any of our stable door hardware.

Photo: The Winterfold in Agate Grey with Satin glazing and Premium Heritage Hardware in Gold with a timber capped aluminium frame

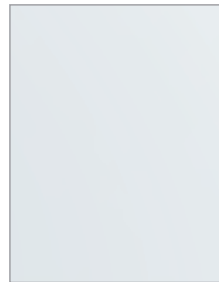

Satin *

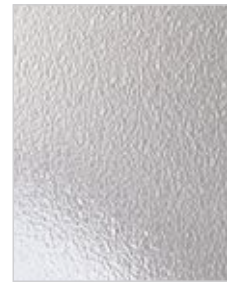

Obscure *

See page 71 for all choices

Timber/PVC-U Clad Aluminium Frame:

Min width : 712mm Max width : 1190mm
 Min height : 1859mm Max height : 2189mm

All sizes exclude Timber sills and extensions
 If a low threshold is required please deduct 7mm from height



* Laminate glass option available

Our decorative glazing designs are supplied with a choice of backing glass from Global Glass see page 71



Classical styling

A beautiful range of traditional doors that bring a classic and luxurious look to your home. Elegant lines and expertly crafted panels combine with modern construction, giving you the very best of both worlds.

Traditional styles

Your front door is the first impression that a visitor has of your home. Whether you want to give the appearance of urban sophistication or something altogether grander, the Craftsman Traditional range has the ideal design.

Our traditional panels and mouldings have an elegant timeless quality that provides your home

with a look of tasteful discernment. Choose one of the stronger hues from our colour palette such as Wax Seal or Bottle for a classic look or choose a natural shade such as French Sage or Vellum for a more contemporary edge.

Whatever you decide, Calibre Craftsman provide the choice and range to make the right impression.

The Sherwood



The Parkhurst



The Arden



The Marston



The Shackleford



The Highgate



The Ashdown



The Charnwood

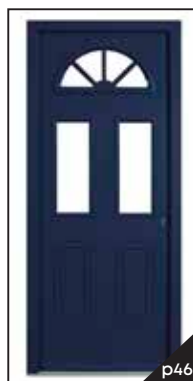

The Newstead



The Epping



The Dean



The Galloway



The Hatfield

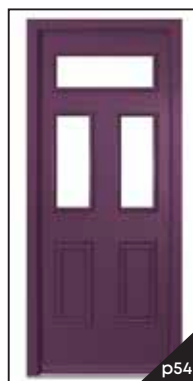

The Silverhill

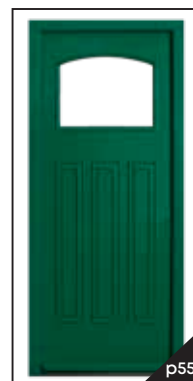

The Kensington

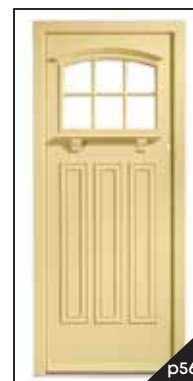

The Sherwood

MFD5



An interesting play on the traditional dual glazed door, the Sherwood gives maximum light through its triple apertures. Choose from Clear, Satin or one of our four Obscure options.

Photo: The Sherwood in Bournville with Satin glazing and ProLinea Polished Chrome hardware



Satin *

Obscure *

See page 71 for all choices

PVC-U Frame:

Min width : 877mm Max width : 1202mm
 Min height : 1980mm Max height : 2195mm

Timber Clad Aluminium Frame:

Min width : 865mm Max width : 1190mm
 Min height : 1974mm Max height : 2189mm

All sizes exclude Timber or PVC-U sills and extensions
 If a low threshold is required please deduct 7mm from height



The Parkhurst

MF23



A stunning addition to the Calibre Craftsman range, the Parkhurst has the classic timeless looks of the 1930's and 40's, with the myriad of benefits of a modern timber engineered door.

Photo: The Parkhurst in Lemon Curd with Clear glazing and ProLinea Polished Gold hardware

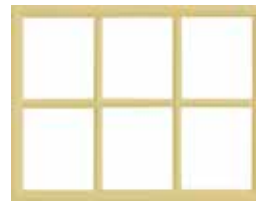

Georgian Fretwork *

Available in door colour with Satin, Obscure or Clear glass



Satin *



Obscure *
See page 71 for all choices

PVC-U Frame:

Min width : 837mm

Max width : 1202mm

Min height : 1935mm

Max height : 2195mm

Timber Clad Aluminium Frame:

Min width : 825mm

Max width : 1190mm

Min height : 1929mm

Max height : 2189mm

All sizes exclude Timber or PVC-U sills and extensions
If a low threshold is required please deduct 7mm from height



* Laminated glass option available

Our decorative glazing designs are supplied with a choice of backing glass from Global Glass see page 71

The Arden

MF11



The Arden is a traditional 6 panel door with two high level lights that may be glazed with a choice of one of our decorative glass options. A classic look for older homes or just as good on a modern dwelling.

Photo: The Arden in Summer Coral with Diamond Cut glazing and ProLinea Polished Gold hardware

PVC-U Frame:

Min width : 837mm	Max width : 1202mm
Min height : 1935mm	Max height : 2195mm

Timber Clad Aluminium Frame:

Min width : 825mm	Max width : 1190mm
Min height : 1929mm	Max height : 2189mm

All sizes exclude Timber or PVC-U sills and extensions
If a low threshold is required please deduct 7mm from height





Diamond Bevel *



Diamond Red *
Also available in Diamond Blue, Grey or Green



Lattice Red *
Also available in Lattice Blue, Green or Bevel



Murano Red *
Also available in Murano Blue, Black, Green or Purple



Dorchester Blue
Also available in Dorchester Amber or Green



Fleur *

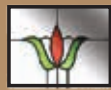

Reflections*



Simplicity
Available in Zinc or Brass (Zinc in lam only)



Prairie *



Finesse



Diamond Cut*



Flair



Crystal Diamond *



Elegance*

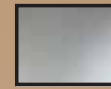

Satin *

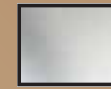

Obscure *
See page 71 for all choices



* Laminated glass option available
Our decorative glazing designs are supplied with a choice of backing glass from Global Glass see page 71

The Marston

MF03



The Marston is our ever popular half glazed door. Allowing light to flood into the room beyond, this stunning door may also be personalised with a decorative glazing panel of your choice.

Photo: The Marston in Peacock with Satin glazing and Sweet Gold hardware

PVC-U Frame:

Min width : 877mm Max width : 1202mm
Min height : 1935mm Max height : 2195mm

Timber Clad Aluminium Frame:

Min width : 865mm Max width : 1190mm
Min height : 1929mm Max height : 2189mm

All sizes exclude Timber or PVC-U sills and extensions
If a low threshold is required please deduct 7mm from height



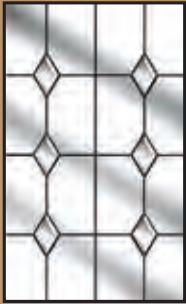

Diamond Bevel *

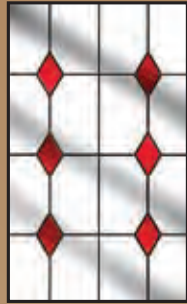

Diamond Red *
Also available in
Diamond Blue, Grey
or Green

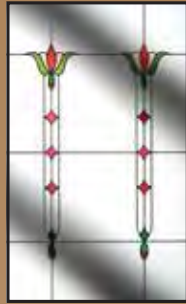

Fleur *



Murano Red *
Also available in
Murano Blue, Black,
Green or Purple



Lattice Red *
Also available
in Lattice Blue,
Green or Bevel



Diamond Cut *



Reflections *

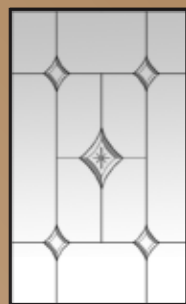

Crystal Diamond *



Elegance*



Simplicity Zinc *



Prairie *



Georgian Fretwork *
Available in
door colour with
Satin, Obscure
or Clear glass



Northumberland
Fretwork *
Available in
door colour with
Satin, Obscure
or Clear glass

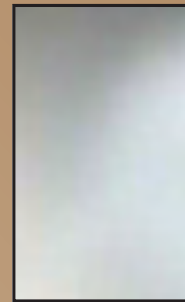

Satin *

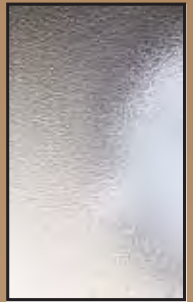

Obscure *
See page 71 for all
choices

* Laminated glass option available
Our decorative glazing designs are supplied with a choice of backing glass from Global Glass see page 71

The Shackelford

MF85

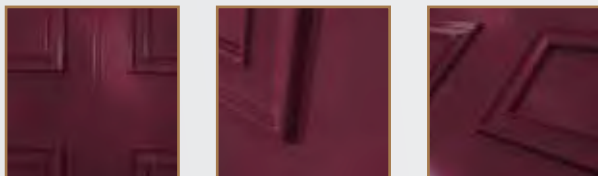

The faux split scratch design of the Shackelford gives the impression of a traditional narrow double door found on many fashionable town-houses without any of the impracticalities.

Photo: The Shackelford in Merlot with Premium Heritage hardware in Pewter and a timber capped aluminium frame

PVC-U Frame:

Min width : 837mm	Max width : 1202mm
Min height : 1935mm	Max height : 2195mm

Timber Clad Aluminium Frame:

Min width : 825mm	Max width : 1190mm
Min height : 1929mm	Max height : 2189mm

All sizes exclude Timber or PVC-U sills and extensions
If a low threshold is required please deduct 7mm from height

The Highgate

MFM2



A true design classic that gives any home a grand appearance, the Highgate, teamed with our beautiful high end door furniture is a favourite for many older properties in town and country.

Photo: The Highgate in Wax Seal with Premium Heritage hardware in Pewter and a timber capped aluminium frame

PVC-U Frame:

Min width : 837mm	Max width : 1202mm
Min height : 1935mm	Max height : 2195mm

Timber Clad Aluminium Frame:

Min width : 825mm	Max width : 1190mm
Min height : 1929mm	Max height : 2189mm

All sizes exclude Timber or PVC-U sills and extensions
If a low threshold is required please deduct 7mm from height



The Ashdown

MF15



The Ashdown is the classic dual glazed option making a smart statement for your home. Choose from our wide range of decorative glazing options to add an additional personal touch.

Photo: The Ashdown in Cambridge Blue with Murano Red glazing with ProLinea Satin Silver hardware and a timber capped aluminium frame

PVC-U Frame:

Min width : 877mm Max width : 1202mm
Min height : 1935mm Max height : 2195mm

Timber Clad Aluminium Frame:

Min width : 865mm Max width : 1190mm
Min height : 1929mm Max height : 2189mm

All sizes exclude Timber or PVC-U sills and extensions
If a low threshold is required please deduct 7mm from height

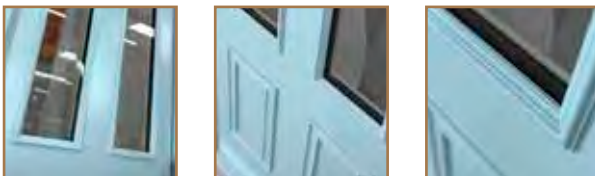

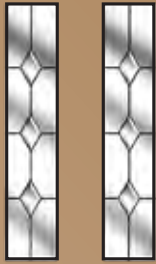

Diamond Bevel *

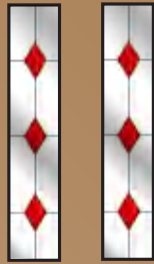

Diamond Red *
Also available in Diamond Blue, Grey or Green



Dorchester Blue
Also available in Dorchester Amber or Green



Fleur *



Murano Red *
Also available in Murano Blue, Black, Green or Purple

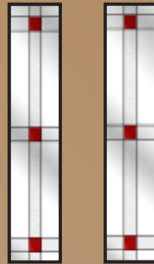

Lattice Red *
Also available in Lattice Blue, Green or Bevel

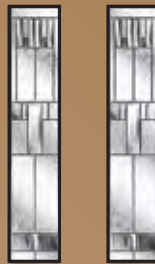

Prairie *

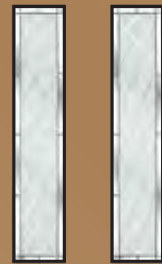

Diamond Cut *

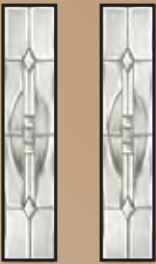

Reflections *



Finesse



Elegance*



Flair

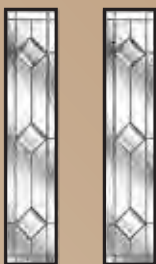

Simplicity *
Available in Zinc or Brass (Zinc in lam only)

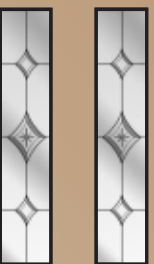

Crystal Diamond *



Satin *



Obscure *
See page 71 for all choices

* Laminated glass option available
Our decorative glazing designs are supplied with a choice of backing glass from Global Glass see page 71

The Charnwood

MFA3



With a half moon top panel and dual rectangular side panels, the Charnwood is a highly decorative door with a host of stunning glazing options to suit, including elegant Georgian bars for the classic sun burst design.

Please note: All decorative glass is available for the 44mm door style only; the clear, obscure, satin and georgian glass styles are available for the 54mm door style only.

Photo: The Charnwood in Savile Row with ProLinea Polished Gold furniture and Dorchester Blue glazing and a timber capped aluminium frame

PVC-U Frame:

Min width : 877mm	Max width : 1202mm
Min height : 1935mm	Max height : 2195mm

Timber Clad Aluminium Frame:

Min width : 865mm	Max width : 1190mm
Min height : 1929mm	Max height : 2189mm

All sizes exclude Timber or PVC-U sills and extensions
If a low threshold is required please deduct 7mm from height

All decorative glass is available for the 44mm door style only



Diamond Bevel *

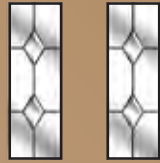

Diamond Red *
Also available in Diamond
Blue, Grey or Green



Fleur *



Murano Red *
Also available in Murano
Blue, Black, Green or Purple



Dorchester Blue
Also available in Dorchester
Amber or Green



Flair



Finesse



Prairie *

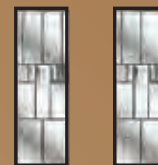

Simplicity
Available in Zinc or Brass



Elegance *

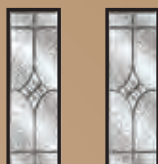

Crystal Diamond *

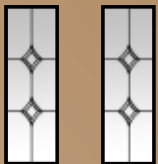

Diamond Cut *



Reflections *



Georgian Bar *
(54mm door only)
Available in door
colour with Satin,
Obscure or Clear glass



Satin *
(54mm door only)



Obscure *
(54mm door only)
See page 71 for all
choices



* Laminated glass option available

Our decorative glazing designs are supplied with a choice of backing glass from Global Glass see page 71

The Newstead

MF04



The Newstead is a half glazed door with a twist. Allowing as much light to flood in as the ever popular Marston, this stunning door enjoys an unusual triple panel design below.

Photo: The Newstead in Chalk Cliff with Fleur glazing and Satin Silver ProLinea Hardware and a timber capped aluminium frame

PVC-U Frame:

Min width : 877mm	Max width : 1202mm
Min height : 1935mm	Max height : 2195mm

Timber Clad Aluminium Frame:

Min width : 865mm	Max width : 1190mm
Min height : 1929mm	Max height : 2189mm

All sizes exclude Timber or PVC-U sills and extensions
If a low threshold is required please deduct 7mm from height





Diamond Bevel *



Diamond Red *
Also available in
Diamond Blue, Grey
or Green

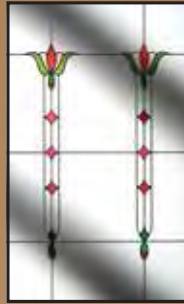

Fleur *



Murano Red *
Also available in
Murano Blue, Black,
Green or Purple

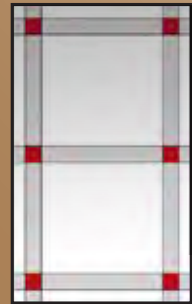

Lattice Red *
Also available
in Lattice Blue,
Green or Bevel



Diamond Cut *



Reflections *

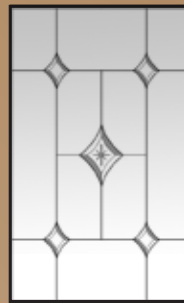

Crystal Diamond *



Elegance *



Simplicity Zinc *



Prairie *

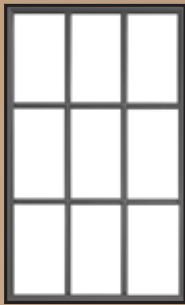

Georgian Bar *
Available in
door colour with
Satin, Obscure
or Clear glass



Northumberland Bar *
Available in
door colour with
Satin, Obscure
or Clear glass

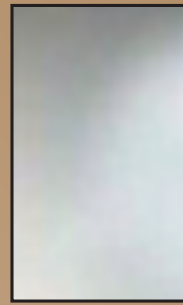

Satin *

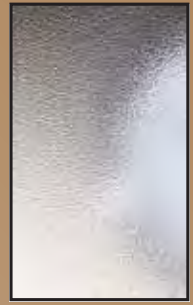

Obscure *
See page 71 for all
choices

* Laminated glass option available
Our decorative glazing designs are supplied with a choice of backing glass from Global Glass see page 71

The Epping

MF14



The Epping teams elegant lines with charming glazing panels ideal for allowing light in and providing you with the opportunity to personalise your home.

Photo: The Epping in Agate Grey with Simplicity glazing and Polished Gold ProLinea hardware with a timber capped aluminium frame

PVC-U Frame:

Min width : 877mm Max width : 1202mm
Min height : 1935mm Max height : 2195mm

Timber Clad Aluminium Frame:

Min width : 865mm Max width : 1190mm
Min height : 1929mm Max height : 2189mm

All sizes exclude Timber or PVC-U sills and extensions
If a low threshold is required please deduct 7mm from height



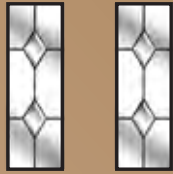

Diamond Bevel *



Diamond Red *
Also available in
Diamond Blue, Grey
or Green

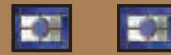

Dorchester Blue
Also available in
Dorchester Amber
or Green

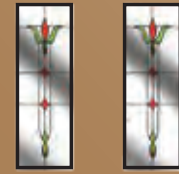
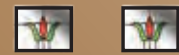

Fleur *



Murano Red *
Also available in
Murano Blue, Black,
Green or Purple

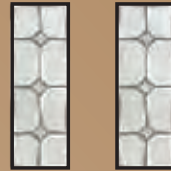

Reflections

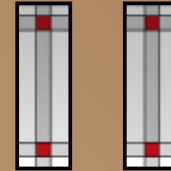

Lattice Red *
Also available
in Lattice Blue,
Green or Bevel

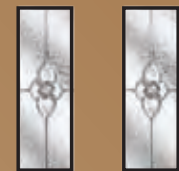

Finesse

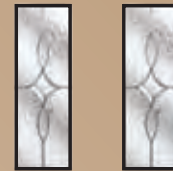

Flair



Diamond Cut *

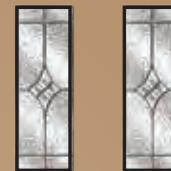

Elegance



Prairie *



Simplicity Zinc

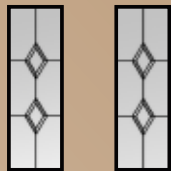

Crystal Diamond *

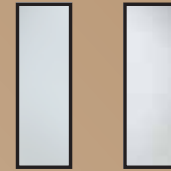

Satin *



Obscure *
See page 71 for all choices

* Laminated glass option available

Our decorative glazing designs are supplied with a choice of backing glass from Global Glass see page 71

The Dean

MF07



The Dean is a smart four panel door with a traditional town-house appearance that looks equally at home on an older property or a more contemporary dwelling.

Photo: The Dean in Whitby Jet with Satin Silver ProLinea hardware and a timber capped aluminium frame

PVC-U Frame:

Min width : 837mm	Max width : 1202mm
Min height : 1935mm	Max height : 2195mm

Timber Clad Aluminium Frame:

Min width : 825mm	Max width : 1190mm
Min height : 1929mm	Max height : 2189mm

All sizes exclude Timber or PVC-U sills and extensions
If a low threshold is required please deduct 7mm from height



The Galloway

MF08



The Galloway is a traditional six panelled door suited to most homes. Whether you are choosing a door for a new build property or a classic town-house, the Galloway is a perfect choice.

Photo: The Galloway in Devonshire with Polished Chrome ProLinea hardware and a timber capped aluminium frame

PVC-U Frame:

Min width : 837mm Max width : 1202mm
Min height : 1935mm Max height : 2195mm

Timber Clad Aluminium Frame:

Min width : 825mm Max width : 1190mm
Min height : 1929mm Max height : 2189mm

All sizes exclude Timber or PVC-U sills and extensions
If a low threshold is required please deduct 7mm from height



The Hatfield

MFM3



The triple apertures of the Hatfield allows for a choice of Satin, Clear or Obscure glass designs that will provide a contemporary look to the entrance of your home.

Photo: The Hatfield in Mulberry with Obscure glazing and ProLinea Satin hardware and a timber capped aluminium frame

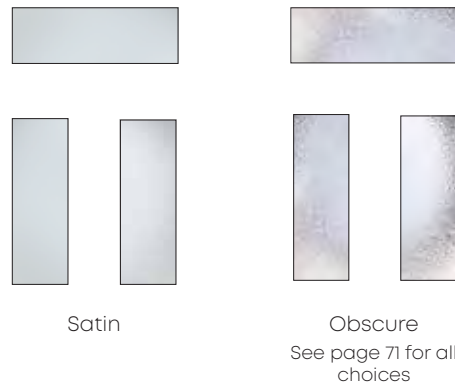

PVC-U Frame:

Min width : 877mm Max width : 1202mm
 Min height : 1935mm Max height : 2195mm

Timber Clad Aluminium Frame:

Min width : 865mm Max width : 1190mm
 Min height : 1929mm Max height : 2189mm

All sizes exclude Timber or PVC-U sills and extensions
 If a low threshold is required please deduct 7mm from height

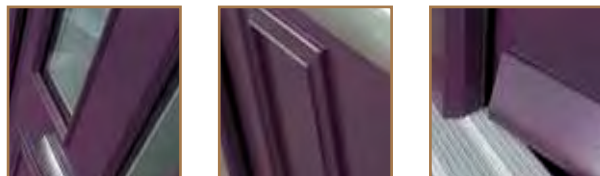

The Silverhill

MFM5



The Silverhill is based on a similar design to the Parkhurst, a classic timeless look of the 1930's and 40's, however the Silverhill, with its beautiful arched window has a charm of its own.

Photo: The Silverhill in Bottle with Obscure glazing and Painted Heritage Brass hardware and a timber capped aluminium frame



Georgian Fretwork
Available in door colour
with Satin, Obscure or
Clear glass

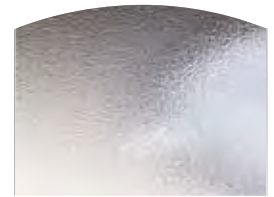

Obscure
See page 71 for all
choices

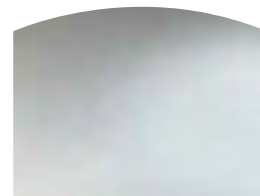

Satin

PVC-U Frame:

Min width : 837mm

Max width : 1202mm

Min height : 1935mm

Max height : 2195mm

Timber Clad Aluminium Frame:

Min width : 825mm

Max width : 1190mm

Min height : 1929mm

Max height : 2189mm

All sizes exclude Timber or PVC-U sills and extensions
If a low threshold is required please deduct 7mm
from height



Our decorative glazing designs are supplied with a choice of backing glass from Global Glass see page 71

* Laminated glass option available

The Kensington

MFM5(K)



The Kensington is a treasured member of the Craftsman family. This gorgeous design is defined by its elegant arched window and striking sculpted features.

Photo: The Kensington in Lemon Curd with Satin glazing and Premium Heritage Pewter hardware with a timber capped aluminium frame

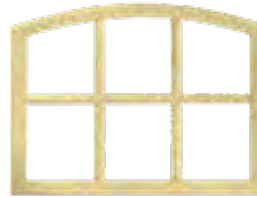

Georgian Fretwork
Available in door colour with Satin, Obscure or Clear glass

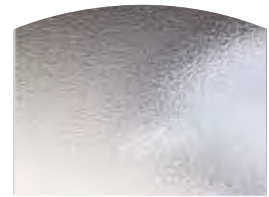

Obscure
See page 71 for all choices

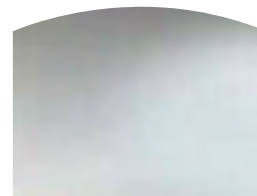

Satin

PVC-U Frame:

Min width : 837mm	Max width : 1202mm
Min height : 1935mm	Max height : 2195mm

Timber Clad Aluminium Frame:

Min width : 825mm	Max width : 1190mm
Min height : 1929mm	Max height : 2189mm

All sizes exclude Timber or PVC-U sills and extensions
If a low threshold is required please deduct 7mm from height



* Laminated glass option available

Our decorative glazing designs are supplied with a choice of backing glass from Global Glass see page 71

Specifications

Panel options

The Calibre Craftsman range is available with a full range of sidelights, toplights and panel options, helping to create the perfect entrance. Frame extenders, and a range of sills and threshold options are also available.

This versatility enables us to match the individual requirements of each installation, to create beautiful entrance ways that are also practical. Contact us for more information or a quote.

See next page for table of minimum and maximum sizes

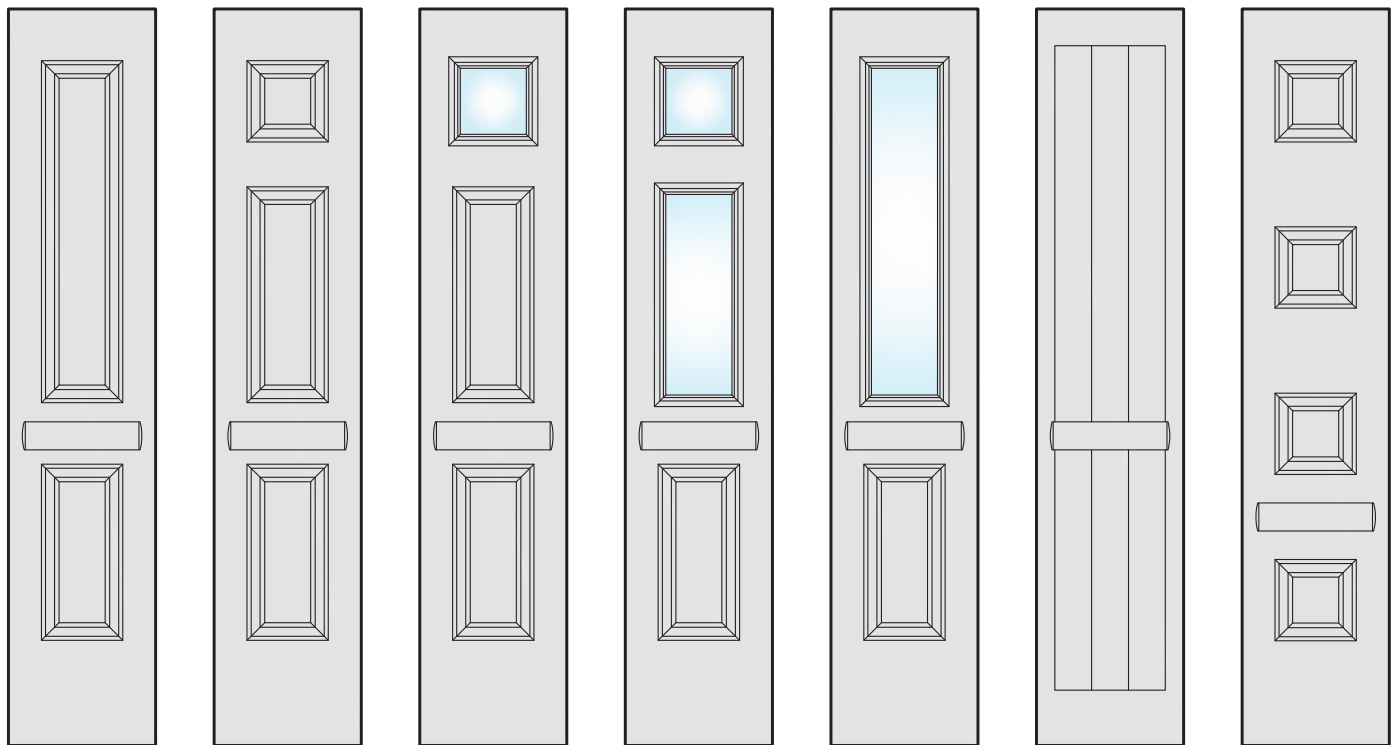

Style A

Ideal for:
The Ashdown
The Dean
The Marston

Style B

Ideal for:
The Galloway
The Epping
The Arden
The Shackleford

Style C

Ideal for:
The Galloway
The Epping
The Arden
The Shackleford

Style D

Ideal for:
The Galloway
The Epping
The Arden
The Shackleford
The Hatfield

Style E

Ideal for:
The Ashdown
The Dean
The Marston

Style F

Ideal for:
The Hampton
The Mercia
The Rockingham
The Portland
The Charlcote
The Heartwood

Style G

Ideal for:
The Highgate

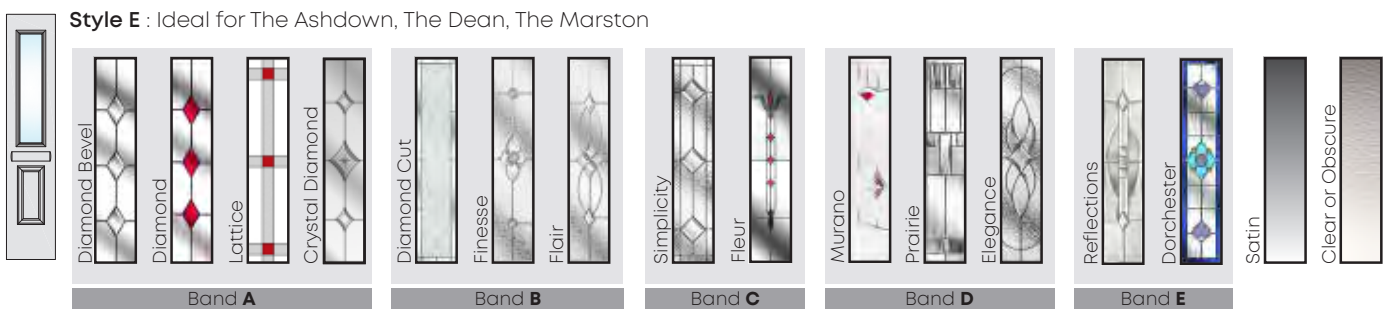
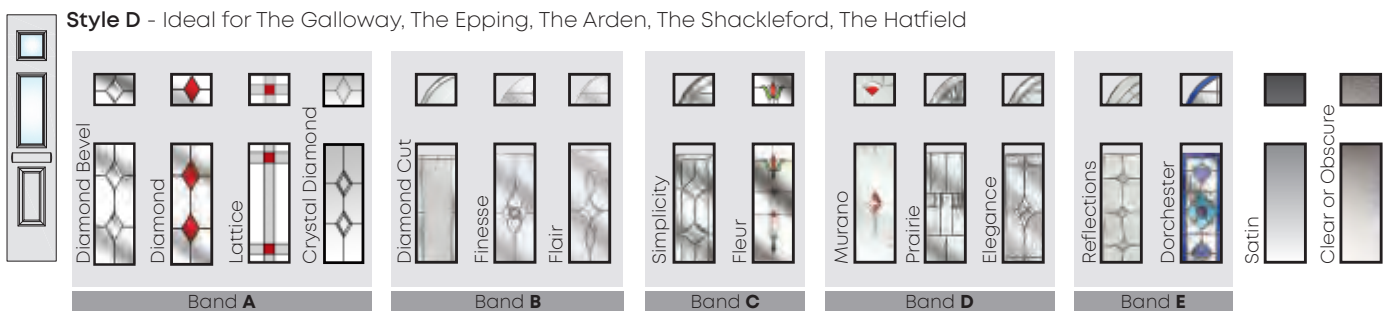
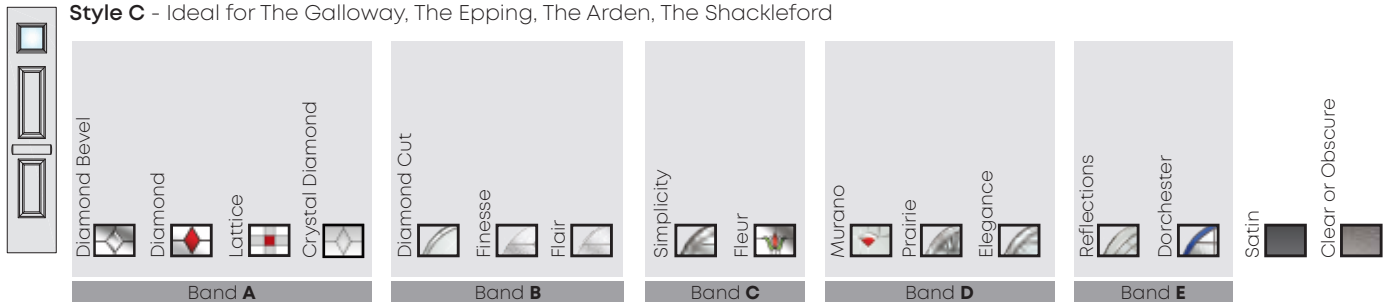

Side Panel Style	Minimum Width with Letter Plate	Minimum Width with No Letter Plate	Maximum Width	Minimum Height	Maximum Height
Style A	495mm	391mm	707mm	1865mm	2195mm
Style B	495mm	391mm	707mm	1865mm	2195mm
Style C	495mm	430mm	707mm	1865mm	2195mm
Style D	495mm	430mm	707mm	1865mm	2195mm
Style E	495mm	430mm	707mm	1865mm	2195mm
Style F	495mm	210mm	707mm	1865mm	2195mm
Style G	495mm	391mm	707mm	1865mm	2195mm

Specifications

PVC-U toplight & sidelight options

Our stunning PVC-U sidelight and toplight combinations allow sunlight to flood into your home. Available in 6 frame colours (see below), these options will compliment your Craftsman door perfectly. Please note: all PVC-U sidelights are seperate frames.

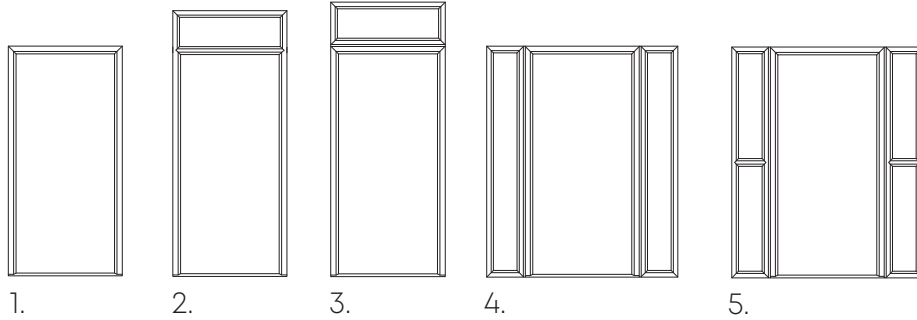

1. Single (Standard)
2. Toplight (Integrated)
3. Toplight (Seperate)
4. Double sidelights
5. Double sidelights with midrails
6. Double sidelights with toplight
7. Double sidelights with toplight and midrails
8. Sidelight
9. Sidelight with midrail
10. Extended sidelight with toplight
11. Extended sidelight with toplight and midrail
12. Sidelight with toplight
13. Sidelight with toplight and midrail
14. Double sidelights with two midrails
15. Sidelight with two midrails

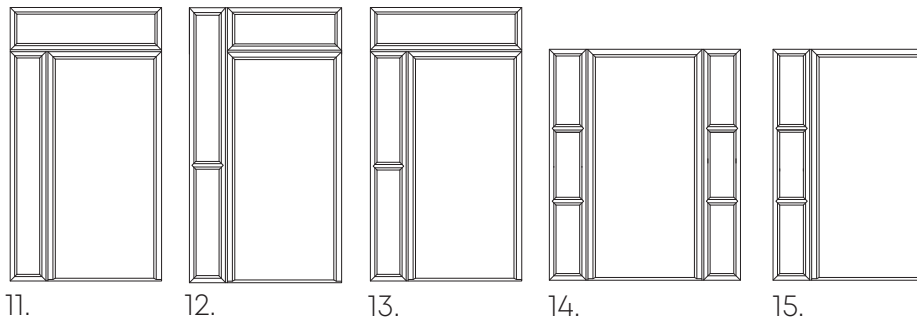
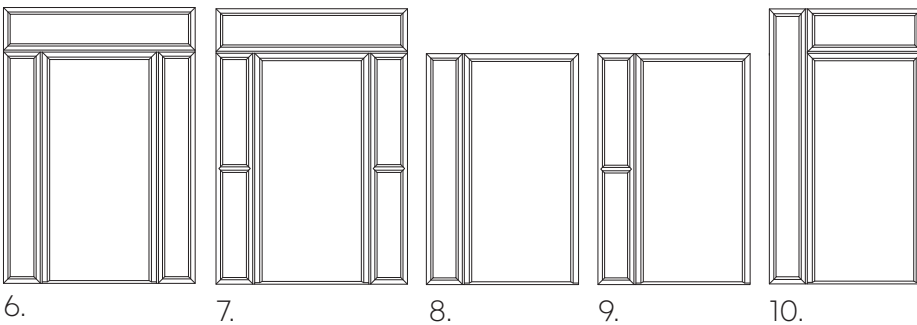

PVC-U Sidelights

Minimum width 254mm
 Maximum width 1314mm
 Maximum height 2100mm

Seperate sidelights are measured from edge of frame to edge of transom

PVC-U frame colour options



Timber Clad Aluminium topline & sidelight options

To complement your precision engineered timber doors, you may select a Timber Clad Aluminium topline, sidelight combination. Painted in the same colour as your door, your chosen combination will be sure to make a stunning addition to your home. Please note: all Timber Clad Aluminium sidelights are integrated frames unless otherwise stated.

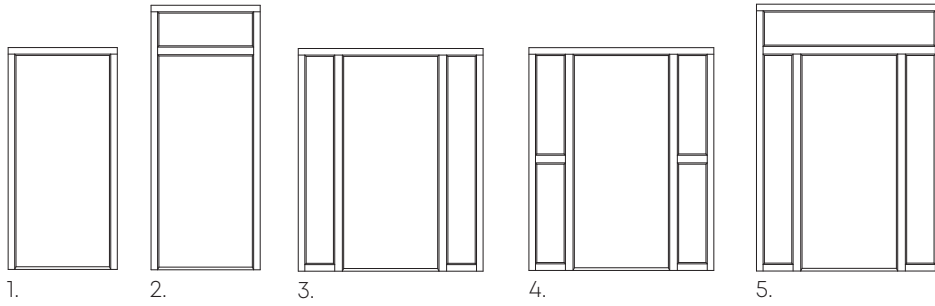

1. Single
2. Toplight
3. Double sidelights
4. Double sidelights with midrails
5. Double sidelights with topline
6. Double sidelights with topline and midrails
7. Sidelight
8. Sidelight with midrail
9. Extended sidelight with topline
10. Extended sidelight with topline and midrail
11. Sidelight with topline
12. Sidelight with topline and midrail
13. Double sidelights with two midrails
14. Sidelight with two midrails

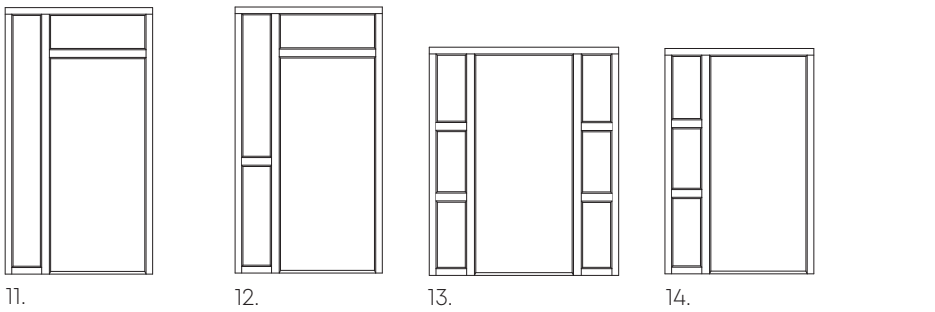
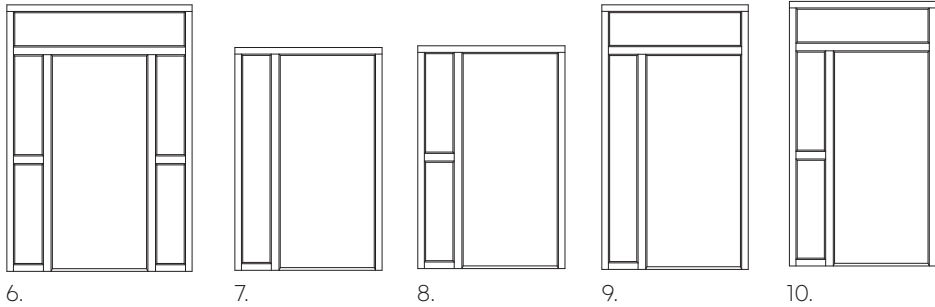

Capped Aluminium Sidelights

Minimum width 230mm
 Maximum width 1290mm
 Maximum height 2190mm

Integrated sidelights are measured from edge of frame to centre of transom

Timber frame colour - to match door colour



See page 61 for more colour details

Backing glass for topline & sidelights

Doors with integrated fan lights above 1350mm wide can have Satin, Clear, Stippolyte or Minster backing glass only

Standard



Additional styles



Specifications

Colour

From soft natural hues to stronger traditional colours, our colour palette offers 24 shades to give your door a unique look. To guarantee your Craftsman door is protected, every door leaves us with two water based layers of colour, two of undercoat and a primer - the equivalent of 10 coats of paint.



Colours are representative only

Please note that all doors are the same colour internally as the external colour unless specified otherwise at the time of ordering.

Specifications



Mechanical guarantee



Surface finish plated guarantee



Surface finish powder coated guarantee

Standard Hardware (Available in Polished Chrome, Polished Gold, Satin Silver and Black)

ProLinea lever/lever handle



Yale 3 Star cylinder (see page 59)



ProLinea lever/pad handle



Kite-marked, anti-bump, anti-snap Euro cylinder

Winkhaus multi-point lock



Calibre hinges



Multi-point locking system

Four stainless steel/brass hinges with fixing position through hinge

Pro-style letterbox



ProLinea door knockers



Victorian Urn (Available with spy hole)

Slimline Victorian Urn (Available with spy hole)

Pony Tail

Modern Oval

Please note: As part of our continued development programme, our standard hardware specification may change without prior notice

Optional Extras

ProLinea spy hole



Ultion Thumbturn



Numerals



Letters A-H also available

Painted Heritage Hardware

Lever/Lever door handles

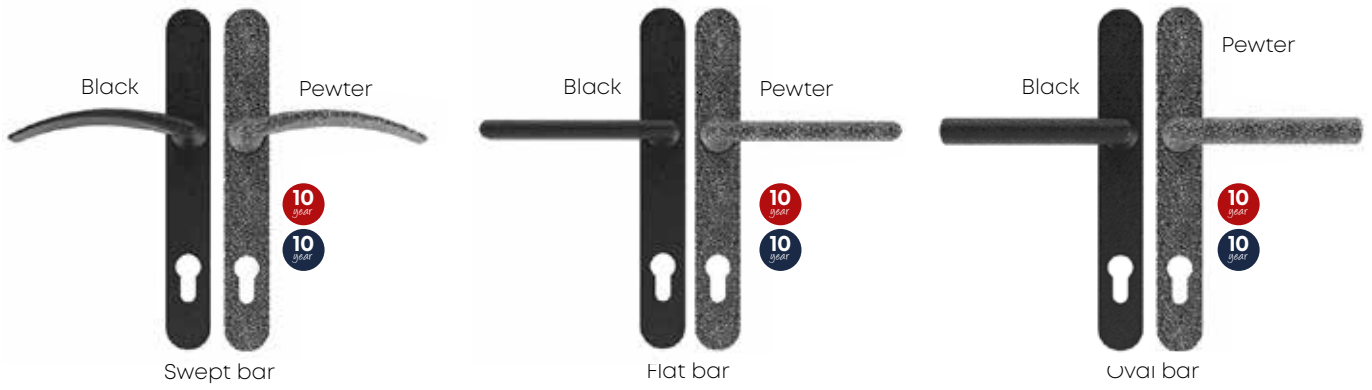

Letterplate



Knockers

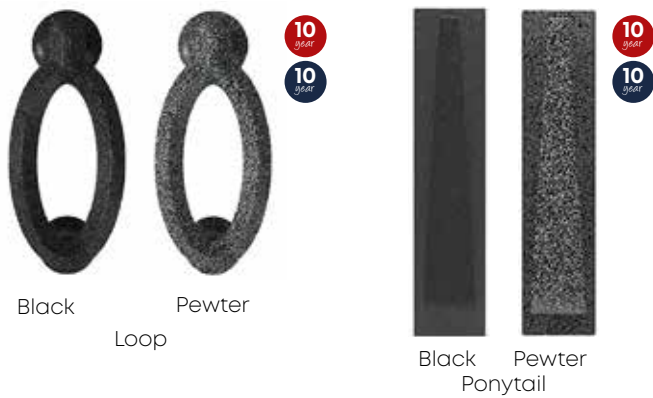



Mechanical guarantee



Surface finish plated guarantee



Surface finish painted guarantee

Premium Heritage Hardware - crafted from the anvil

Door handles and pulls



Lever door handle - Cottage



Lever door handle - Avon



Lever door handle - Gothic



Octagonal centre door pull



Art Deco centre door pull



Letterbox

Letterbox

Knockers



Door Knocker - Pear



Door Knocker - Loop
(Black only)



Door Knocker - Shakespeare



Art Deco Door Knocker

Escutcheon



Premium Brass and Chrome Hardware - crafted from the anvil

Door handles and pulls



Reeded lever door handle



Art Deco centre door pull

Escutcheon



Letterbox



Letterbox

Knockers



Doctors Door Knocker



Door Knocker - Loop



Art Deco Door Knocker

Specifications

Contemporary Brushed Stainless Steel Hardware

Door handles

Bar Handles (off-set available)

Bar - 600mm

Bar - 1000mm

Bar - 1200mm

Bar - 1400mm

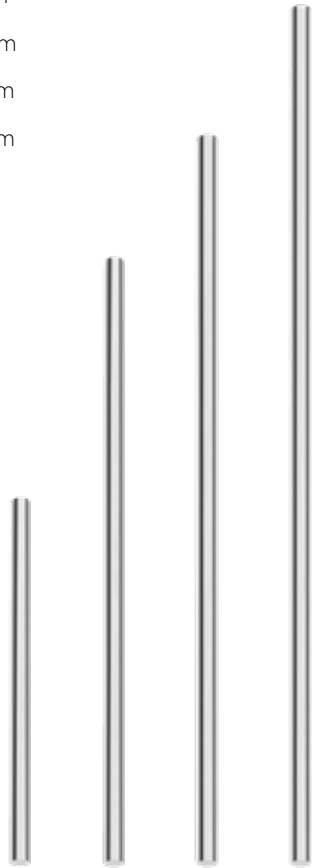

(Handle options available both sides - pull escutcheon required if handle fitted externally only)

25 year



V Handle

25 year



Bow Handle

25 year



Centre Door Pull (external only)

25 year

Knockers



Pony Tail

25 year



Ingot

25 year

Letterplate



Brushed Stainless Steel finish

5 year

Escutcheons



Standard



Standard with Pull

25 year



Security



Security with Pull

25 year



Mechanical guarantee



Surface finish plated guarantee



Polished surface guarantee



Surface finish powder coated guarantee

Stable Door Hardware

Please note that, as standard, our Stable Doors come with ProLinea handles, a pair of escutcheons and a KfV Lock. If the Premium Heritage Hardware is required then you will

need to order Premium Heritage hardware: handles and a sliding bolt. The Winkhaus lock comes as standard with the Premium Heritage hardware.

Standard Stable Hardware (Available in Polished Chrome, Polished Gold, Satin Silver and Black)

ProLinea lever/lever handle



ProLinea escutcheons



Pull escutcheons

KfV Lock



Multi-point locking system with internal opening/locking mechanism

Premium Heritage Stable Hardware - crafted from the anvil

Black and Pewter Door Handles



Lever door handle - Cottage



Lever door handle - Avon



Lever door handle - Gothic

Winkhaus Lock **10 year**



Multi-point locking system

Gold and Chrome Door handles



Lever door handle

Sliding bolt



Escutcheons



Secured By Design Letterbox Upgrade

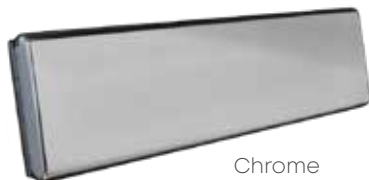

Chrome



Gold

Specifications

Ultion Upgrade

Using uniquely patented Snap Secure technology, Ultion is anti-snap, pick, drill and bump resistant, and is easy to fit with no additional prep and no need for cylinder guards or security handles. Ultion is 3 star rated straight out of the box, with a lock down mode that activates an attack lock directly into the central cam, keeping an intruder out whilst still being unlockable from the inside - keeping homes and families safe.

Ultion locks are continuously tested; having passed the Sold Secure Diamond Test, it has not yet been beaten. And with the attack lock being housed in Molybdenum, one of the best superalloys in use today, it's little wonder that Ultion has been described as having transformed the door market.

ULTION



Thumbturn option available



Enters Lock Down Mode when it detects attack



3 Star TS007 Test rating, Sold Secure Diamond rating



Over 294,000 combinations produced by 11 pins



Double anti-snap protection, with 6 hardened steel rods and two plates in both ends

The £1,000 Ultion Snap Guarantee

Ultion are offering a FREE 10 year guarantee to homeowners - just register at www.ultion-lock.co.uk within 28 days of installation, and if your home gets burgled as a result of your Ultion lock getting snapped in the following 10 years, you will receive £1,000.



Very few things go with us everywhere, our keys do. Keycap makes your keys look great and feel much more comfortable whether in your pocket or your hand. A wide variety of colourful caps are available, including glow in the dark options so they are easier to use at night.

Keyring brings all the benefits of Keycap with built in bluetooth. Track or activate the alarm in your keys from your phone and you'll never lose them again!

To order additional keys, please contact Ultion on 0115 784 3162.



Sweet Hardware Upgrade

Why shouldn't extreme personal protection look stunning? With Sweet's unique 'edgeless' design, it always does. Whether your home is contemporary or traditional, country-style or modern urban, Sweet stays effortlessly cool.

Sweet carries multiple coatings of copper and nickel, ensuring it always looks great, even after being hammered with salt water for over 5000 hours. That's an incredible 20x more times than required for the flagship EN 1906:2012 corrosion standard. And with 3 super sleek colours to choose from, there's a sweet for everyone.



Door handles



Gold



Black



Chrome

Knockers



Gold



Black



Chrome

Escutcheons



Gold



Black



Chrome

Letter box



Gold



Black



Chrome

Specifications

Glazing options

10
year

We have selected the most popular glazing options best suited to your Craftsman door. From contemporary designs to the more traditional glass styles,

we know you will find the perfect look for your chosen application. Although not available in every door style, the following images give an indication of appearance.

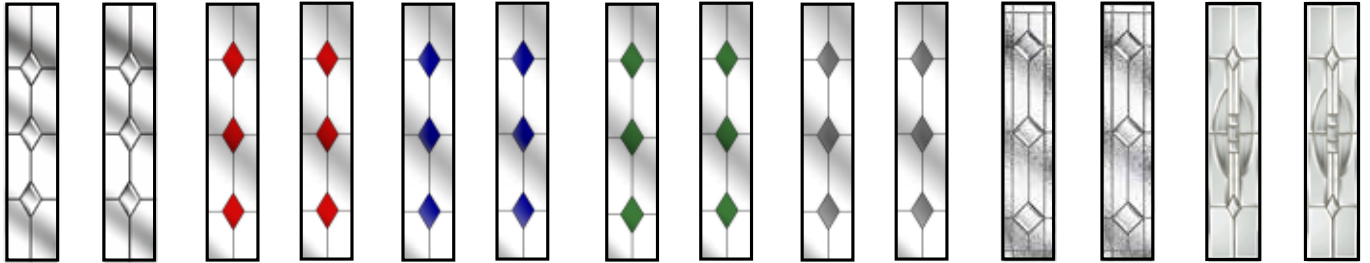

Diamond Bevel * Diamond Red * Diamond Blue * Diamond Green * Diamond Grey * Simplicity Zinc * Reflections *



Murano Blue * Murano Black * Murano Green * Murano Purple * Murano Red * Finesse Flair

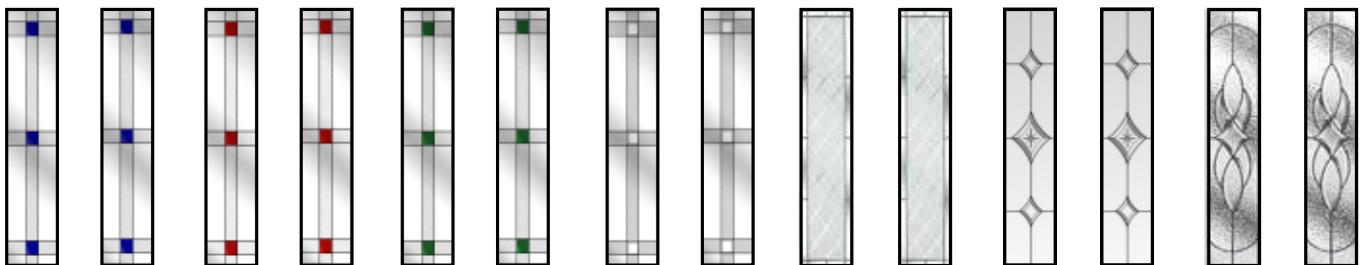

Lattice Blue * Lattice Red * Lattice Green * Lattice Bevel * Diamond Cut * Crystal Diamond * Elegance

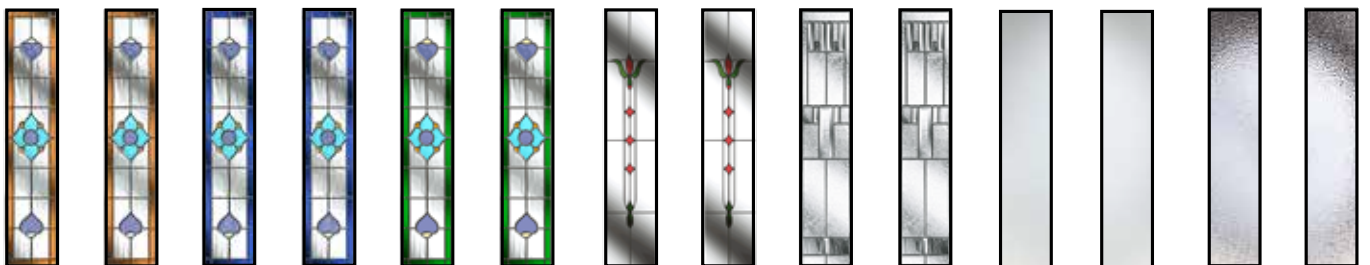

Dorchester Amber Dorchester Blue Dorchester Green Fleur * Prairie * Satin * Obscure *

* Laminated glass option available

Our decorative glazing designs are supplied with a choice of backing glass from Global Glass see opposite page

Specifications

-  Guarantee against glass unit failure
-  Mechanical guarantee



Low E, energy efficient glazing

Glazing in a GRP composite door will always reduce its thermal efficiency, but by installing our Low E option wherever possible, we can help negate that effect, which is better for the environment and better for your pocket.

Backing glass options

10 year

Standard Selection



Additional Styles



Yale 3* Cylinder Upgrade

10 year

We also supply the Yale Platinum Euro Profile cylinder across the Calibre range. This cylinder is an anti-pick, anti-bump, anti-pull, anti-drill and anti-screw solution offering the full 3* rating, making it one of the most secure cylinders available. Calibre are committed to the safety and security of you and your home.

TS007:2014 3 star approved BS EN1303:2005 approved KM559658

Ultion Upgrade

The Ultion range offers the ultimate security to your home. Using uniquely patented Snap Secure technology, Ultion is anti-snap, pick, drill and bump resistant, and is easy to fit with no additional prep and no need for cylinder guards or security handles.

Ultion is 3 star rated straight out of the box, with a lock down mode that activates an attack lock directly into the central cam, keeping an intruder out whilst still being unlockable from the inside - keeping homes and families safe.

Ultion locks are continuously tested; having passed the Sold Secure Diamond Test, it has not yet been beaten. And with the attack lock being housed in Molybdenum, one of the best superalloys in use today, it's little wonder that Ultion has been described as having transformed the door market.



Specifications

Frame, Sill and Threshold Options

Often it is the finishing touches to a project that make all the difference. To achieve the perfect look for your home with crucial functionality, Calibre offers a choice of frame, threshold and sill options to suit your requirements.

Frame options

Standard PVC-U chamfered outerframe (White only)

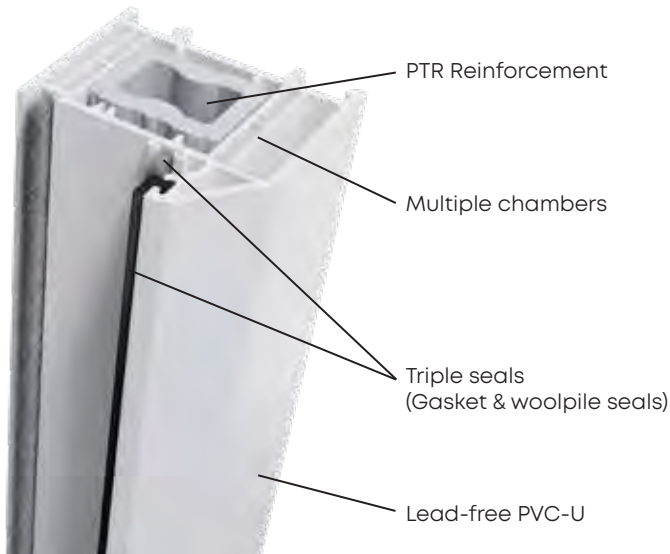

- **Multi-chamber profile**
With 8 chambers, our multi-chambered frames give an impressive thermal performance as standard
- **Environmentally friendly frames**
Lead-free profile and plastic thermal reinforcements (PTRs) are both thermally efficient and incredibly strong with the added bonus of being light and quick to install
- **Triple sealed**
Our innovative system uses three gaskets to reduce heat loss and improve weather-tightness
- **Secure construction**
With 72% better screw retention than through steel, PTRs offer more secure fixing of hardware keeping your frame rigid, stable and secure

Timber clad aluminium outerframe

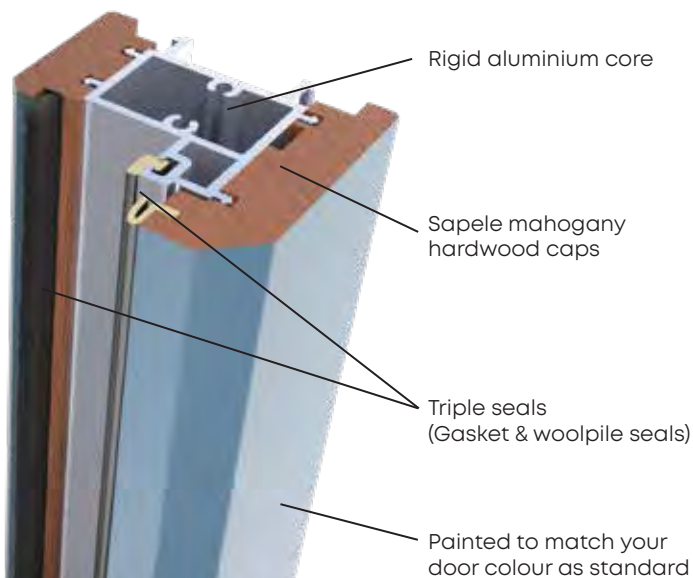

- **Factory finished paint to match chosen door colour**
We colour your frame as standard to seamlessly mirror your chosen door colour
- **Triple sealed**
Our aluminium/timber system uses three gaskets to reduce heat loss and improve weather-tightness
- **Secure as standard**
The very construction of the timber clad aluminium frame means that the frame itself is incredibly strong and almost impossible to penetrate
- **Security Plus (SP) aluminium frame**
The rigid, high security frame and its engineered construction stops warping and twisting

Threshold options

Aluminium door thresholds to prevent rain and draughts under the door

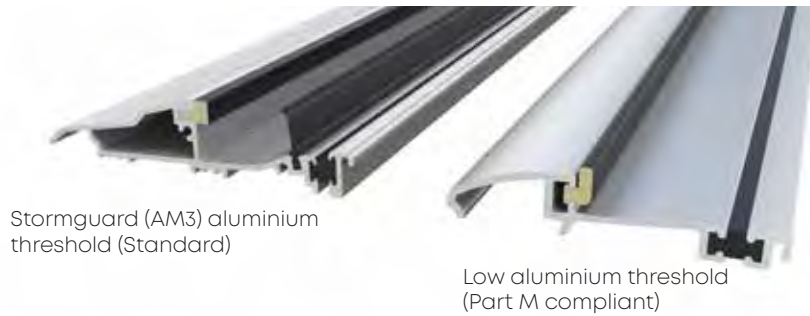

Stormguard (AM3) aluminium threshold (Standard)

Low aluminium threshold (Part M compliant)

You have a choice of thresholds from Calibre, the standard offering is the Stormguard (AM3) aluminium threshold with a height of 25mm.

The low aluminium threshold, on the other hand, is just 15mm high and creates a low step when your door is open. The low threshold is suitable for disabled and wheelchair access and is Part M compliant.

Sill options

Timber sill

Timber sills are available as shown or painted Black or White as standard. You may also colour match to your door and frame.



94mm stub sill

144mm sill

174mm sill

PVC-U sill

PVC-U sills will match your PVC-U door frame as standard.

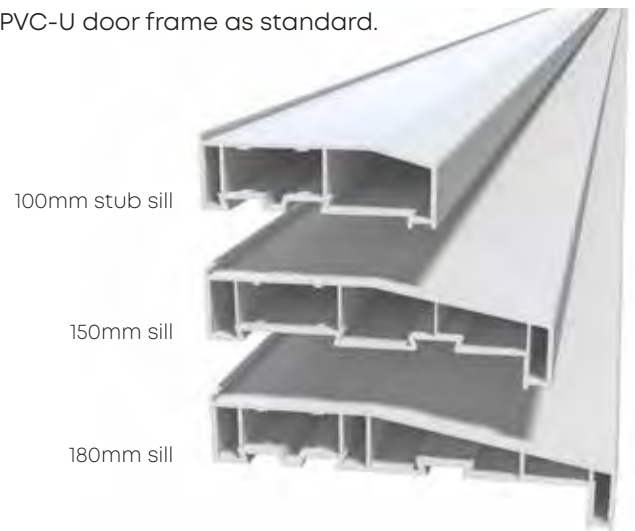

100mm stub sill

150mm sill

180mm sill

Frame extensions

To ensure the very best fit for your Calibre Craftsman door we supply a range of frame extensions in both PVC-U and hardwood options in various sizes.



PVC-U 25mm

PVC-U 44mm

Timber 10mm

Timber 20mm

Craftsman Guarantee

10
year

10
year

Engineered Timber Door

The unique build of the Craftsman door provides a stable, strong weatherproof construction. Guaranteed for 10 years, the Craftsman door is an investment in your home for years to come.

10
year

Glazing

Our double glazed units are known for their beauty, quality and longevity. A 10 year guarantee on all our glazing units means excellent thermal performance and good looks for the future.

10
year

Capped Aluminium Frame

An incredibly strong, rigid frame, the Craftsman capped aluminium frame has a structural guarantee of 10 years, making it one of the most secure and hardworking frames on the market.

5 year **10** year **15** year **25** year

Hardware

Not only a matter of personal taste, our hardware range gives you choices in guarantees ranging from 5 years through to 25 years too. (See pages 59-63 for more details)

10
year

10
year

PVC-U Door Frame

Our reinforced PVC-U frame requires little maintenance and provides a rigid frame for your Craftsman door. Whether you choose white or a woodgrain foil our frames are guaranteed for 10 years.

5
year

Threshold

Whether easy access or weather protection are your deciding factors, our aluminium thresholds are guaranteed for a reassuring 5 years.



Mechanical guarantee



PVC-U Surface guarantee



Polished surface guarantee



Surface finish plated guarantee

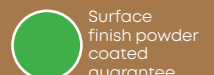

Surface finish powder coated guarantee



Foils guarantee



Surface finish anodised guarantee



Structural guarantee



Guarantee against glass unit failure

Thermal and solid core to meet Document L compliance

As part of our commitment to offer only the very best doors available, all Craftsman doors meet Building Regulations for replacement doors - Document L compliance. See table below for details and availability of door styles, frame type and internal core that meet Document L's required energy ratings.

Core:	44mm Door Slab				54mm Door Slab			
	Solid Core	Solid Core	Thermal Core	Thermal Core	Solid Core	Solid Core	Thermal Core	Thermal Core
Frame Type:	Timber/Alu Capped Frame	PVC-U Frame	Timber/Alu Capped Frame	PVC-U Frame	Timber/Alu Capped Frame	PVC-U Frame	Timber/Alu Capped Frame	PVC-U Frame
Albury	○	○	●	●	○	●	●	●
Arden	○	○	●	●	○	●	●	●
Ashdown	●	●	●	●	●	●	●	●
Charlcote	●	●	○	○	○	○	○	○
Charnwood	●	●	●	●	●	●	●	●
Dalby	○	○	●	●	○	●	●	●
Dean	○	○	●	●	○	●	●	●
Epping	●	●	●	●	●	●	●	●
Foxley	○	●	●	●	○	●	●	●
Galloway	○	○	●	●	○	●	●	●
Glengarry	○	○	●	●	○	●	●	●
Hampton	○	○	●	●	○	●	●	●
Hatfield	●	●	●	●	●	●	●	●
Heartwood	●	●	○	○	○	○	○	○
Highgate	○	○	●	●	○	●	●	●
Kensington	○	○	●	○	○	●	●	○
Marston	●	●	●	●	●	●	●	●
Mercia	○	○	●	●	○	●	●	●
Newstead	●	●	●	●	●	●	●	●
Parkhurst	○	○	●	●	○	●	●	●
Portland	●	●	○	○	○	○	○	○
Shackleford	○	○	●	●	○	●	●	●
Sherwood	●	●	●	●	●	●	●	●
Silverhill	○	○	●	●	○	●	●	●
Rockingham	○	○	●	●	○	●	●	●
Rufford	○	○	●	●	○	●	●	●
Wentwood	○	○	●	●	○	●	●	●
Winterfold	●	●	○	○	○	○	○	○
Whinfell	●	●	○	○	○	○	○	○
Whittingham	○	○	●	●	○	●	●	●

● - Document L Compliant ○ - Unavailable

Accreditations

Calibre continually strives for - and achieves - excellence



The Kitemark is a UK product and service quality certification mark which is owned and operated by The British Standards Institution (BSI Group) and is achieved through rigorous testing only at a centre of excellence.



CE Marking is a mandatory conformity marking for products sold within the European Economic Area (EEA) since 1985 and is indicative of Calibre's complete compliance with EU legislation.



The national body for the accreditation of testing and calibration laboratories, certification and inspection bodies, UKAS is the sole national accreditation body, of which we are a proud member.



CHAS is a health and safety accreditation scheme for the construction industry, as CHAS accredited, we are committed to annual assessments to show we are maintaining the high levels of health and safety management required.



Sold Secure Diamond is a test developed in conjunction with the Master Locksmiths Association. It is designed by locksmiths, and very few locks pass the test. Ours do.



Secured by Design focuses on crime prevention of homes and commercial premises and promotes the use of security standards for a wide range of applications and products.



ISO 14001 is an internationally agreed standard that sets out the requirements for environmental management, to improve through more efficient use of resources and reduction of waste.



PEFC Chain of Custody is the process of handling information on the origin of forest-based products and allows us to make accurate claims on the content of sustainably certified material.

Customer support

At Calibre, our experienced and skilled customer care team is always on hand to provide technical advice, answer any door style enquiries, provide installation advice and to assist with project enquiries. We ensure that our customers have all the information they require to make the best choice and to provide excellent service.

How to use this brochure

In designing this brochure, we aim to provide you with all the information you need in order to choose the perfect door solution. At your finger tips, you have detailed product information, photographs, hardware choices, quality guarantees and glazing options.

Ordering from us (Available to Trade Customers only)

To place your order with us, you can do it in one of four ways:

Phone : **01773 850605**
Fax : **01773 853336**
Email : **tradesales@calibredoors.com**
Online : **www.calibredoors.com**

Be sure to have your account number handy when making your order, so we can find your business details quickly on our system.

We have the technical know-how

Unsure what door or hardware would be best for a specific job? Our team has specialist working knowledge of our product range, give them a call for helpful technical advice and support.

You can trust us to deliver

We measure our success in accurately providing what you ordered, quickly and on time. Our composite door range is now bigger and better than ever before and we keep our stock holding high so you don't have to. Remember: keep us informed if you are planning a large project and we will make sure we have everything you need in stock.



Call our team for support and advice

Dedicated customer services team

The role of the customer care team is to resolve any queries or issues you may have and we aim to respond promptly to your needs. In the event that problems arise, please do get in touch and we will do what we can to help you resolve the issue.







Craftsman doors – maximum choice, style and security



Tel 01773 850605 | Fax 01773 853336 | www.calibredoor.com

Calibre Doors | Firs Works | Spanker Lane | Nether Heage | Derbyshire | DE56 2JJ